

# Autonics

## CAPACITIVE PROXIMITY SENSOR (CYLINDRICAL AC, DC TYPE)

### CR SERIES

M A N U A L



Thank you very much for selecting Autonics products.  
For your safety, please read the following before using.

#### Caution for your safety

※Please keep these instructions and review them before using this unit.

※Please observe the cautions that follow;

**Warning** Serious injury may result if instructions are not followed.

**Caution** Product may be damaged, or injury may result if instructions are not followed.

※The following is an explanation of the symbols used in the operation manual.

**Caution:** Injury or danger may occur under special conditions.

#### Warning

1. In case of using this unit with machinery(Ex: nuclear power control, medical equipment, ship, vehicle, train, airplane, combustion apparatus, safety device, crime/disaster prevention equipment, etc) which may cause damages to human life or property, it is required to install fail-safe device.  
It may cause a fire, human injury or damage to property.

2. Do not connect power directly without load.  
It may cause damage to inner components or burn them out.

#### Caution

- Do not use this unit in place where there is flammable, explosive gas, chemical or strong alkalis, acids.  
It may cause a fire or explosion.
- Do not impact on this unit.  
It may cause malfunction or damage to the product.
- Please observe the rated specification and do not supply AC power on DC type product.  
It may cause in serious damage to the product.

#### Ordering information

<b>C</b>	<b>R</b>	<b>30</b>	<b>-</b>	<b>15</b>	<b>D</b>	<b>N</b>	<b>O</b>	Normally open
							<b>C</b>	Normally closed
							<b>N</b>	NPN normally open
							<b>N2</b>	NPN normally closed
							<b>P</b>	PNP normally open
							<b>D</b>	12-24VDC
							<b>A</b>	100-240VAC
							<b>Number</b>	Standard sensing distance(Unit: mm)
							<b>Number</b>	Diameter of head(Unit: mm)
							<b>R</b>	Cylindrical type
							<b>C</b>	Capacitive proximity sensor

#### Dimensions

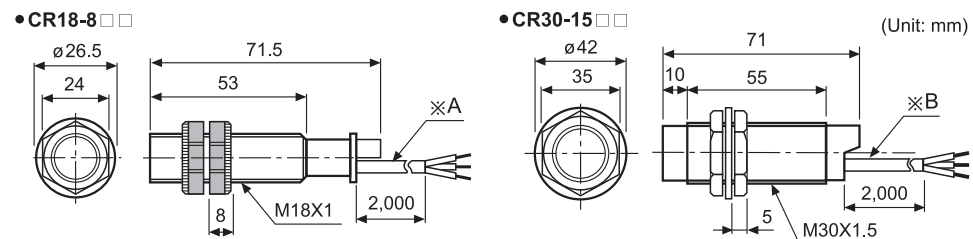

※'A' type:  $\phi 4$ , 2 cores/ $\phi 4$ , 3 cores(Conductor cross section: 0.3mm<sup>2</sup>, Insulator diameter:  $\phi 1.25$ )  
 ※'B' type:  $\phi 5$ , 2 cores/ $\phi 5$ , 3 cores(Conductor cross section: 0.3mm<sup>2</sup>, Insulator diameter:  $\phi 1.25$ )

※The above specifications are subject to change and some models may be discontinued without notice.

#### Specifications

Model	CR18-8DN CR18-8DP CR18-8DN2	CR30-15DN CR30-15DP CR30-15DN2	CR18-8AO CR18-8AC	CR30-15AO CR30-15AC
Sensing distance	8mm	15mm	8mm	15mm
Hysteresis	Max. 20% of sensing distance			
Standard sensing target	50X50X1mm(Iron)			
Setting distance	0 to 5.6mm	0 to 10.5mm	0 to 5.6mm	0 to 10.5mm
Power supply(Voltage range)	12-24VDC(10-30VDC)		100-240VAC 50/60Hz(85-264VAC)	
Current consumption	Max. 15mA		-	
Leakage current	-		Max. 2.2mA	
Response frequency*1	50Hz		20Hz	
Residual voltage	Max. 1.5V		Max. 20V	
Affection by Temp.	$\pm 20\%$ Max. of sensing distance at 20°C within temperature range of -25 to 70°C			
Control output	Max. 200mA		Max. 5 to 200mA	
Insulation resistance	Min. 50M $\Omega$ (at 500VDC megger)			
Dielectric strength	1500VAC 50/60Hz for 1minute			
Vibration	1mm amplitude at frequency of 10 to 55Hz in each of X, Y, Z directions for 2 hours			
Shock	500m/s <sup>2</sup> (50G) X, Y, Z directions for 3 times			
Indicator	Operation indicator:Red LED			
Environ-ment	Ambient temperature	-25 to 70°C, Storage: -30 to 80°C		
	Ambient humidity	35 to 95%RH, Storage: 35 to 95%RH		
Protection circuit	Reverse polarity protection, Surge protection		Surge protection circuit	
Protection	IP66(IEC standard)	IP65(IEC standard)	IP66(IEC standard)	IP65(IEC standard)
Material	CR18 - Case and nut: PA6, General cable(Black): Polyvinyl chloride (PVC) CR30 - Case and nut: Nickel-plated brass, Washer: Nickel-plated steel Sensing part: Heat-resistant ABS, General cable(Black): Polyvinyl chloride (PVC)			
Unit weight	Approx. 76g	Approx. 206g	Approx. 70g	Approx. 200g

※1: The response frequency is the average value. The standard sensing target is used and the width is set as 2 times of the standard sensing target, 1/2 of the sensing distance for the distance.  
 ※Environment resistance is rated at no freezing or condensation.

#### Control output diagram & Load operation

##### DC 3-wire type

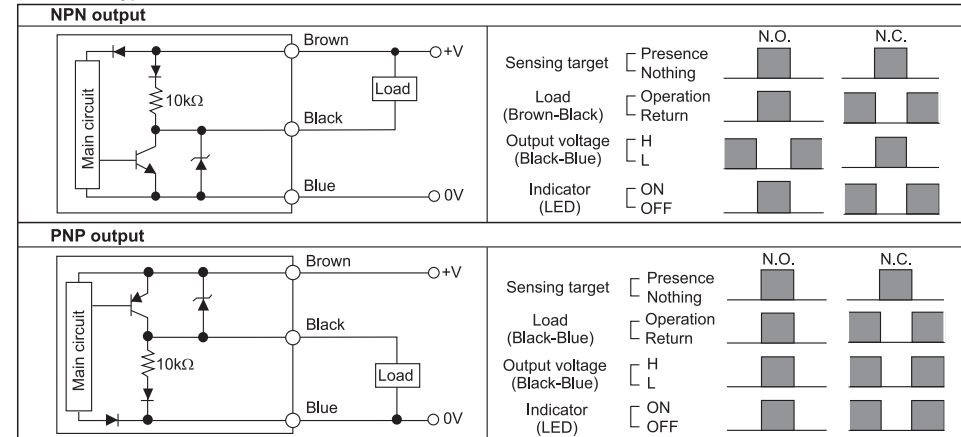

##### AC 2-wire type

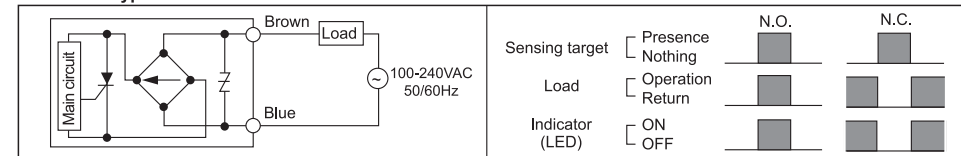

#### Connections

##### DC 3-wire type

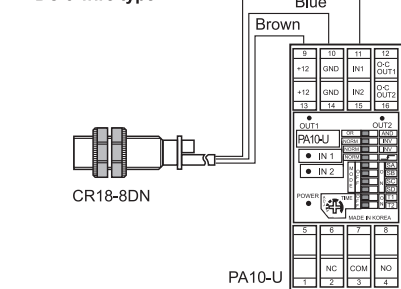

##### AC 2-wire type

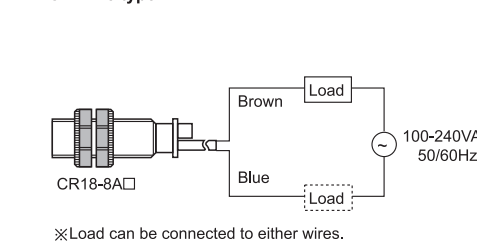

#### Grounding

The sensing distance will be changed by grounding status of capacity proximity sensor and the target[50 X 50 X 1mm(Iron)]. Please check the material when installing the sensor and selecting the target.

##### CR18

Ground condition(switch b)	ON	OFF
Operating distance(mm)	8	4

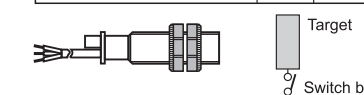

##### CR30

Ground condition	Switch a	ON	OFF	ON	OFF
	Switch b	ON	ON	OFF	OFF
Operating distance(mm)		15	18	6	6

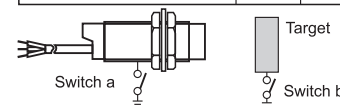

#### Sensitivity adjustment

• Please turn potentention VR to set sensitivity as below procedure.

① Without a sensing object, turn the potentention VR to the right and stop at the proximity sensor is ON(OFF).

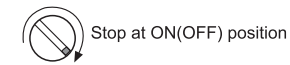

② Put the object in right sensing position, turn the potentention VR to the left and stop at the proximity sensor is OFF(ON).



③ If the difference of the number of potentention VR rotation between the ON(OFF) point and the OFF(ON) point is more than 1.5 turns, the sensing operation will be stable.

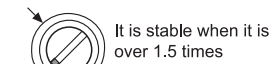

OFF(ON) position ON(OFF) position

④ If it is set in sensitivity adjustment position of potentention VR at center between ① and ②, sensitivity setting will be completed.



OFF(ON) position ON(OFF) position

※When there is distance fluctuation between proximity sensor and the target, please adjust ② at the farthest distance from this unit.  
 ※Turning potentention VR toward clockwise, it will be max., or turning toward counter clockwise, it will be min. The number of adjustment should be 15 $\pm$ 3 revolution and if it is turned to the right or left excessively, it will not stop, but it idles without breakdown.  
 ※( ) is for Normally closed type.

#### Mutual-interference & Influence by surrounding metals

• **Mutual-interference**  
 When several proximity sensors are mounted closely, malfunction of sensor may be caused due to mutual interference. Therefore, be sure to keep a minimum distance between the two sensors, as below charts.

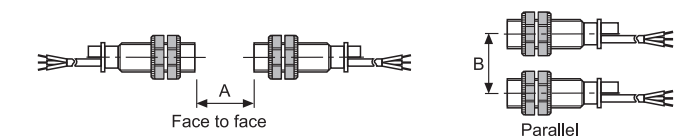

##### Influence by surrounding metals

When sensors are mounted on metallic panel, it is required to protect the sensors from malfunction by any metallic object. Therefore, be sure to keep a minimum distance as below charts.

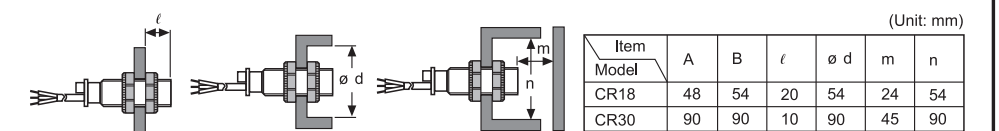

#### Caution for using

- This equipment shall not be used outdoors or beyond specified temperature range.
- Do not apply over tensile strength of cord. ( $\phi$  4: Max. 30N,  $\phi$  5: Max. 50N)
- Do not use the same conduit with cord of this unit and electric power line or power line.
- Do not put overload to tighten nut, please use the supplied washer for tightening.

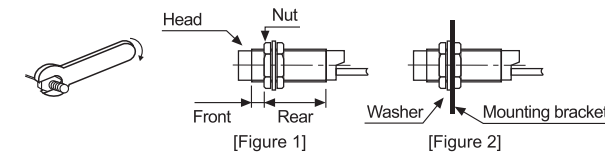

Model	Strength Front		Rear
	Size	Torque	Torque
CR30	12mm	500kgf-cm (49N-m)	800kgf-cm (78.4N-m)

Note1) Allowable tightening torque of a nut may be different by the distance from the head. For allowable tightening torque and the range of front and rear parts, refer to [Table 1] and above [Figure 1] respectively. The front part range is from head to the size of [Table 1] and the rear part includes a nut (see above [Figure 1]).

Note2) The allowable tightening torque denotes a torque value when using a provided washer as above [Figure 2].

- Please check the voltage changes of power source in order not to exceed the rated power input.
- Do not use this unit during transient time(80ms) after applying power.
- Do not connect capacity load to output part directly.
- It may result in damage to this product, if using automatic transformer. So please use insulated transformer.
- Please make wire short as much as possible in order to avoid noise.
- Be sure to use cable as indicated specification on this product. If using wrong cable or banded cable, it shall not have waterproof properties.
- It is possible to extend cable with over 0.3mm<sup>2</sup> and max. 200m.
- If the target is plated, the operating distance can be changed by the plating material.
- It may result in malfunction by metal particle on product.
- If there are machines(motor, welding etc), which occur big surge around this unit, please install the Varistor or absorber to source of surge, even though there is built-in surge absorber in this unit.
- If connecting the load with big inrush current(DC type bulb) to this unit, the big inrush current will flow because the initial resistance is low. If the current flows, the resistance of load will be bigger, then it will return to standard current. In this case, proximity sensor might be damaged by inrush current. If you use DC type bulb, please connect extra relay or current limit resistor in order to protect proximity sensor.
- In case of the load current is low(AC type): When the load current is under 5mA, make the residual voltage is less than return voltage by connecting the bleeder resistor and load in parallel to flow 5mA to proximity sensor.  
 ※110VAC 50/60Hz: 20k $\Omega$ , Min. 3W, 220VAC 50/60Hz: 39k $\Omega$ , Min. 5W
- If making a transceiver close to proximity sensor or wire connection, it may cause malfunction.

※It may cause malfunction if above instructions are not followed.

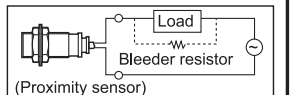

#### Major products

- Photoelectric sensors
- Fiber optic sensors
- Door sensors
- Door side sensors
- Area sensors
- Proximity sensors
- Pressure sensors
- Rotary encoders
- Connector/Sockets
- Switching mode power supplies
- Control switches/Lamps/Buzzers
- I/O Terminal Blocks & Cables
- Stepper motors/drivers/motion controllers
- Graphic/Logic panels
- Field network devices
- Laser marking system(Fiber, CO<sub>2</sub>, Nd:YAG)
- Laser welding/soldering system
- Temperature controllers
- Temperature/Humidity transducers
- SSR/Power controllers
- Counters
- Timers
- Panel meters
- Tachometer/Pulse(Rate)meters
- Display units
- Sensor controllers

**Autonics Corporation**  
<http://www.autonics.com>

**Satisfiable Partner For Factory Automation**

■ **HEAD QUARTERS:**  
 18, Bansong-ro 513beon-gil, Haeundae-gu, Busan, Korea

■ **OVERSEAS SALES:**  
 #402-404, Bucheon Techno Park, 655, Pyeongcheon-ro, Wonmi-gu, Bucheon, Gyeonggi-do, Korea  
 TEL: 82-32-610-2730 / FAX: 82-32-329-0728  
 ■ E-mail: sales@autonics.com

EP-KE-07-0140D